

GRATE BOLTED TO FRAME w/
1/2 - 13 X 2 1/2 STNLS. STL.
HEX. HD. CAP SCREW w/ WASHER

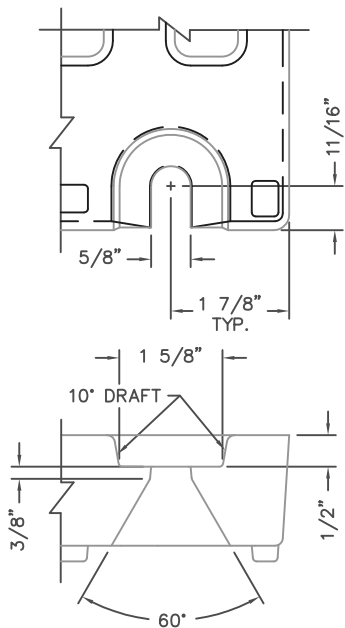

BOLT SLOT DETAIL
SCALE 1:2

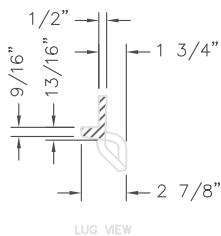
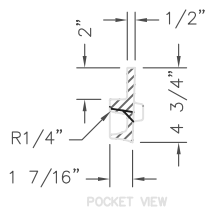
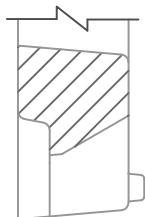

SECTION VIEWS

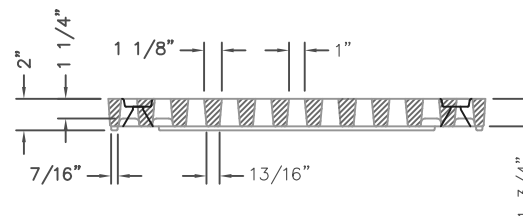
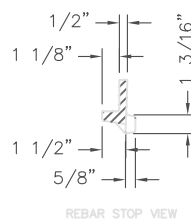

**R-4990-BA AIRPORT TRENCH
TYPE "A" GRATE w/ TYPE "B" FRAME
TYPICAL SECTION**

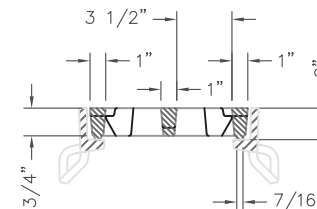

STD. COMPONENT NOS.: SIDE PC. FRAME 4999-2400;
END PC. FRAME 4990-3110; GRATE 4999-0010
MATERIAL: CAST GRAY IRON ASTM A-48, CLASS 35B
FINISH: NO PAINT

DR.	CAG	SCALE	TITLE:	R-4990-BA AIRPORT STYLE TRENCH TYPE "A" GRATE w/ TYPE "B" FRAME
CH.		1/8"=1"		
APP.		DIM CHK.	NEENAH FOUNDRY NEENAH WISCONSIN 54956	NF-4990BAAB B
DATE	07-24-2012			
www.neenahfoundry.com			PHONE: 1-800-558-5075	