

Location: _____



T1800-PEO

**COMBINATION END OUTLET / END CAP FOR ALL
T1800 POLYMER CONCRETE CHANNELS**

Specification: MIFAB® T1800-PEO end outlet and end cap with 6" or 8" socket connection to secure to end of channel. Manufactured from plastic material.

Function: Used to provide an end outlet connection or end cap for MIFAB's various T1800 polymer concrete channels. Guide marks across the top of the part indicate where it is to be cut to match the finished height of the selected T1800 channel.

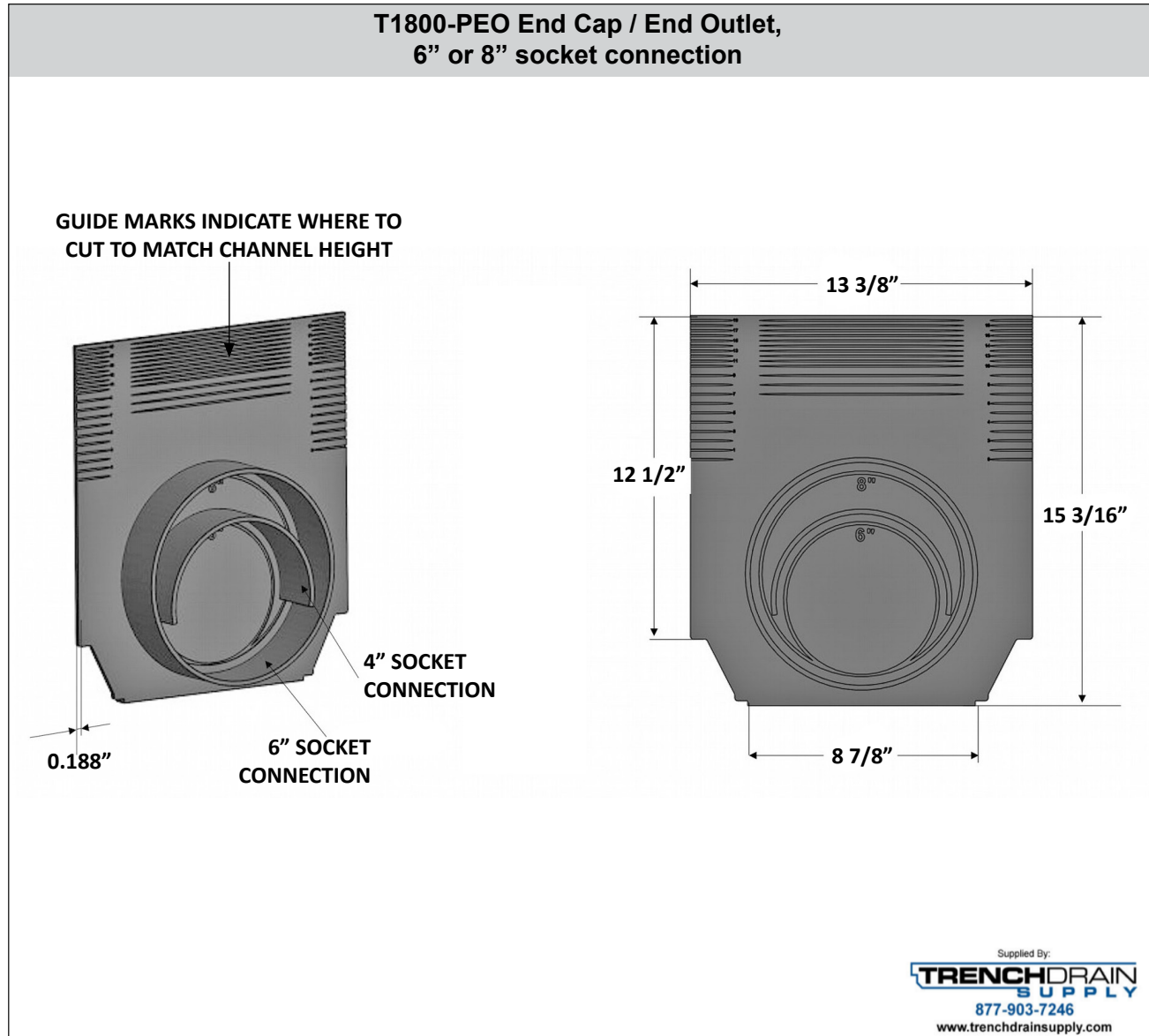

CALIFORNIA PROPOSITION 65 WARNING. This product contains chemicals known to the State of California to cause cancer and birth defects or other reproductive harm.

Job Name: _____ Page No: _____
Section No: _____ Contractor: _____
Schedule No: _____ Purchase Order No: _____

MIFAB reserves the right to make changes in material and design without formal notice and obligation.

USA: 1-800-465-2736 www.mifab.com CAN: 1-800-387-3880

2023-04-21